

NOW AVAILABLE UP TO 6M* LONG X 4M* WIDE
*nominal

ALUMINIUM INTERNALS TOO!



ultraSky
by ultraframe





Flood
light
into your
home
with an
UltraSky
rooflight

ultraSky
by ultraframe

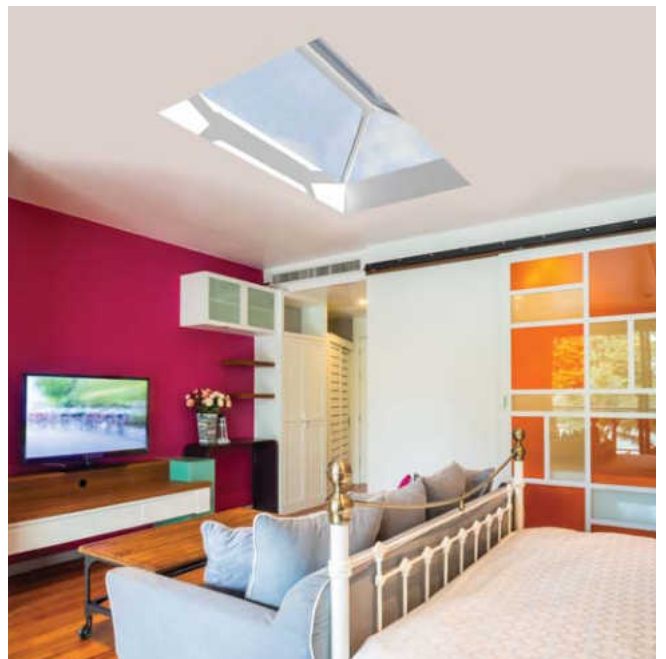
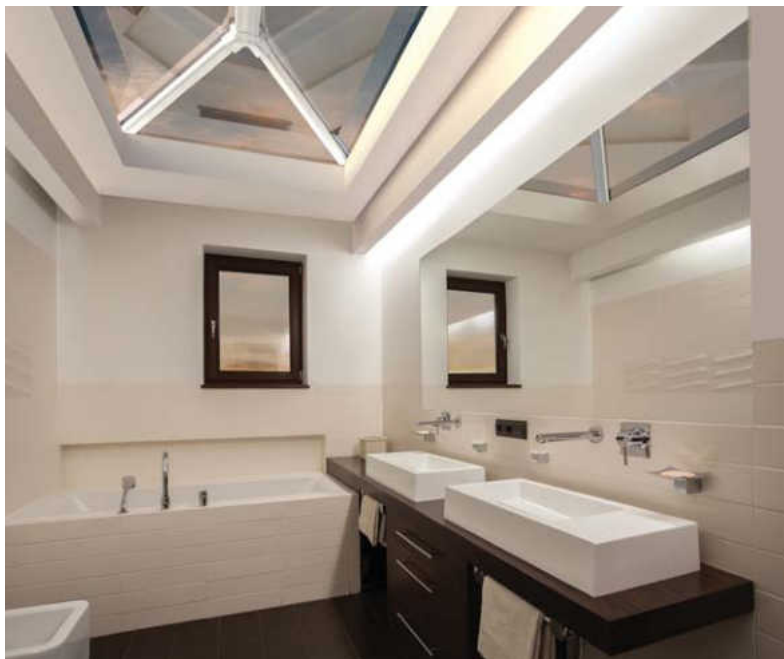
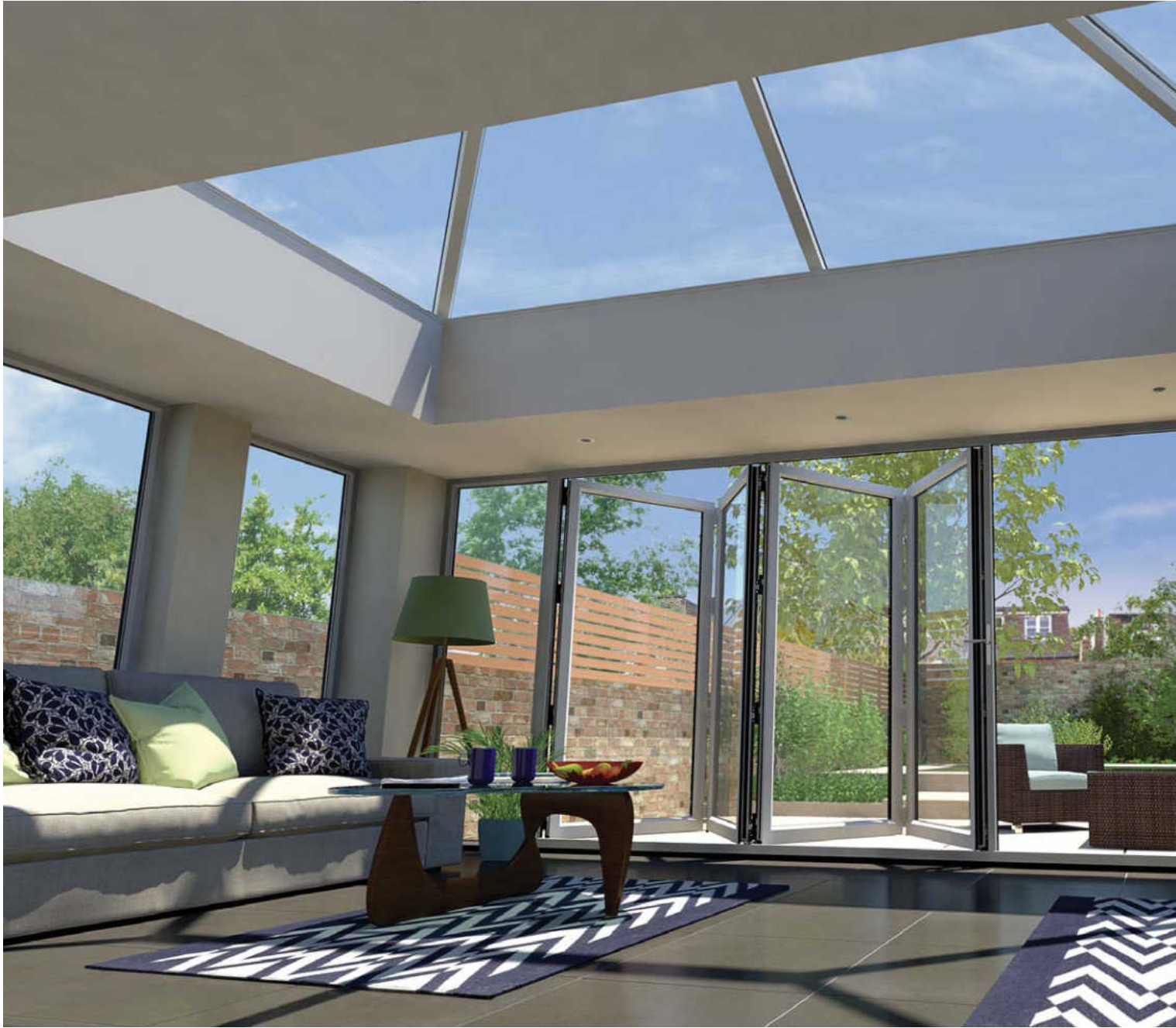

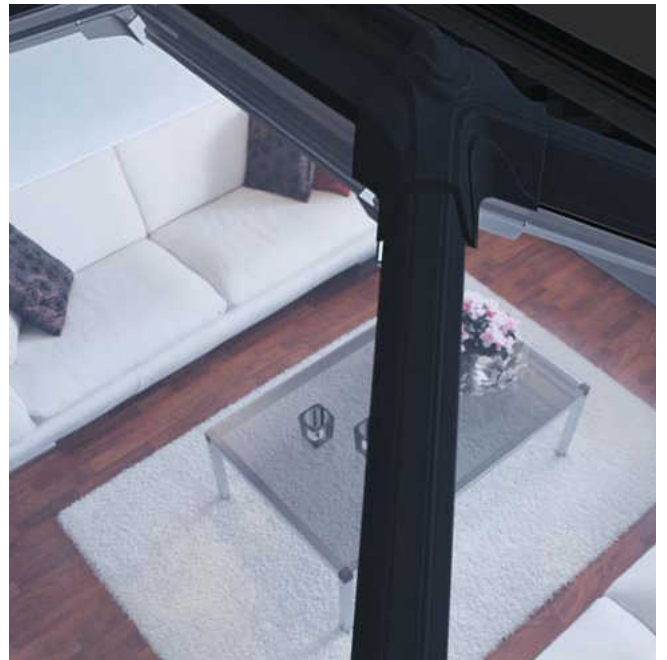

Installed on a new build extension, Orangery, or inserted into an existing flat roof, an UltraSky rooflight will help you add the feeling of space and natural light to your home

Whether it's for a living room, dining room, kitchen, bedroom or bathroom the UltraSky rooflight will be the perfect stylish solution for you.



ultraSky
by ultraframe



The UltraSky rooflight is stunning, enhancing any style of property, traditional or modern alike

SIZES

The UltraSky rooflight is available in a number of bespoke rectangular sizes ranging from up to 6m* long x 4m* wide.

COLOUR OPTIONS

Choose the stylish White PVC option to match your modern window frames, or for that extra “Wow” factor go for the Aluminium option, available in White, Anthracite Grey or Satin Black. Internally the rooflight is clad in either white PVC or powder coated aluminium in white, anthracite grey or satin black to either match or contrast the external finish.

GLAZING

The highly thermally efficient glazing options will help reduce heat loss and noise pollution, whilst letting the desired amount of light into your room.

EXTRAS

Add a roof vent to let in the fresh air – Roof vents are available with a manual opener, automatic opener or an automatic opener with rain and temperature control. Roof vents only available in selected sizes.

*Max length/width are nominal sizes

RADIUS END: EXTERNAL & INTERNAL ALUMINIUM



RADIUS END: EXTERNAL & INTERNAL ALUMINIUM

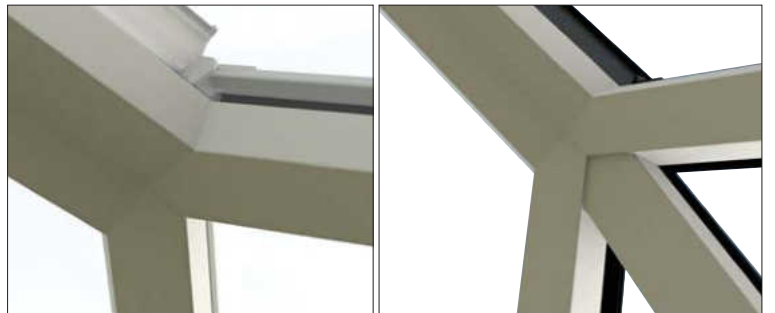

A timber kerb of 150mm high x 70mm wide(not supplied) must be fitted around the opening in the flat roof – weatherproofing membrane of clients choice laps onto top face of kerb



UltraSky is based on the tried and tested BBA approved Ultraframe Classic roofing system



KEY PERFORMANCE CRITERIA

Rectangular double ended rooflights, with a width up to 4000*mm and a length up to 6000*mm (*Max length/width are nominal sizes).

25 degree fixed pitch to all four sides.

Glazing bar top caps in either chambered PVC (white only) or aluminium (White RAL 9003 80% gloss, Anthracite Grey RAL 7016 30% gloss and Satin Black RAL 9005 60% gloss).

Internal finishing options in white PVC or powder coated aluminium (to match external colour range - dual colour option).

Thermally broken aluminium ridge body.

Low profile eaves beam (no gutter) designed to be fitted with oversailing 24mm double glazed units (high performance low e, self cleaning and solar control in blue or neutral/clear - units can be supplied with the rooflight).

UltraSky is designed around maximum uninterrupted sight lines – bar numbers are reduced (or can be added if you prefer) and the ridge board and hub ends are as unobtrusive as possible.

The thermal performance has been optimised to make it suitable for extensions in domestic properties. Typical U value with 1.1 glass for a 1000mm wide x 2000mm long rooflight is 1.4 W/m2K.

*Width and length are defined as to the external face of the timber kerb (not supplied, recommended to be 150mm high x minimum of 70mm wide).

IMPORTANT.
SET OUT & DIMENSIONS ARE ALWAYS MEASURED TO EXTERNAL FACE OF KERB

Typical design - Small eg., 3m x 1.5m shown

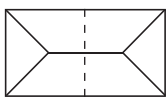

(optional additional bars - shown dotted)

Typical design - Larger sizes eg., 4m x 2m shown

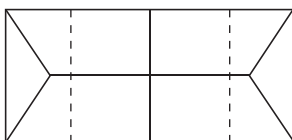

(optional additional bars - shown dotted)

HIP BAR

Thermally broken Ridge and Classic aluminium glazing bar featuring foam insulation

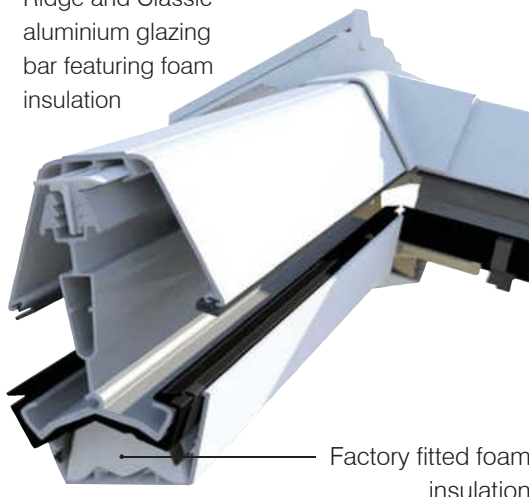



Conservatories



Orangeries



Extensions